

# INSPIRON™

## SETUP GUIDE



YOURS IS HERE



# INSPIRON™

## SETUP GUIDE

Regulatory model: P10F series

Regulatory type: P10F001; P10F002

# Notes, Cautions, and Warnings

 **NOTE:** A NOTE indicates important information that helps you make better use of your computer.

 **CAUTION:** A CAUTION indicates either potential damage to hardware or loss of data and tells you how to avoid the problem.

 **WARNING:** A WARNING indicates a potential for property damage, personal injury, or death.

If you purchased a Dell™ n Series computer, any references in this document to Microsoft® Windows® operating systems are not applicable.

This item incorporates copy protection technology that is protected by U.S. patents and other intellectual property rights of Rovi Corporation. Reverse engineering and disassembly are prohibited.

---

**Information in this document is subject to change without notice.**

**© 2010 Dell Inc. All rights reserved.**

Reproduction of these materials in any manner whatsoever without the written permission of Dell Inc. is strictly forbidden.

Trademarks used in this text: *Dell*, the *DELL* logo, *YOURS IS HERE*, *Inspiron*, *Solution Station*, and *DellConnect* are trademarks of Dell Inc.; *Intel*, *Pentium*, and *Centrino* are registered trademarks and *Core* is a trademark of Intel Corporation in the U.S. and other countries; *Microsoft*, *Windows*, *Windows Vista*, and the *Windows Vista* start button logo are either trademarks or registered trademarks of Microsoft Corporation in the United States and/or other countries; *AMD*, *AMD Athlon*, *AMD Turion*, *AMD Phenom*, and *ATI Mobility Radeon* are trademarks of Advanced Micro Devices, Inc.; *Blu-ray Disc* is a trademark of the Blu-ray Disc Association; *Bluetooth* is a registered trademark owned by Bluetooth SIG, Inc. and is used by Dell under license.

Other trademarks and trade names may be used in this document to refer to either the entities claiming the marks and names or their products. Dell Inc. disclaims any proprietary interest in trademarks and trade names other than its own.

**October 2010**

**P/N 9N1F7**

**Rev. A04**

# Contents

<b>Setting Up Your Inspiron Laptop</b> . . . . .	<b>5</b>	<b>Using Your Inspiron Laptop</b> . . . . .	<b>24</b>
Before Setting Up Your Computer . . . . .	5	Right View Features . . . . .	24
Connect the AC Adapter . . . . .	6	Left View Features . . . . .	26
Connect the Network Cable (Optional) . . . . .	7	Back View Features . . . . .	28
Press the Power Button . . . . .	8	Front View Features . . . . .	29
Set Up the Operating System . . . . .	9	Status Lights and Indicators . . . . .	30
Create System Recovery Media (Recommended) . . . . .	10	Computer Base and Keyboard Features . . . . .	32
Install the SIM Card (Optional) . . . . .	12	Touch Pad Gestures . . . . .	34
Enable or Disable Wireless (Optional) . . . . .	14	Multimedia Control Keys . . . . .	36
Set Up Wireless Display (Optional) . . . . .	16	Using the Optical Drive . . . . .	38
Connect to the Internet (Optional) . . . . .	18	Display Features . . . . .	40
Install Software Using Dell Digital Delivery . . . . .	22	Removing and Replacing the Battery . . . . .	42
		Software Features . . . . .	44
		Dell DataSafe Online Backup . . . . .	45
		Dell Dock . . . . .	46

## Contents

<b>Solving Problems</b> .....	<b>47</b>	<b>Getting Help</b> .....	<b>69</b>
Beep Codes .....	47	Technical Support and Customer Service .....	70
Network Problems .....	48	DellConnect™ .....	70
Power Problems .....	49	Online Services .....	71
Memory Problems .....	50	Automated Order-Status Service .....	72
Lockups and Software Problems .....	50	Product Information .....	72
<b>Using Support Tools</b> .....	<b>53</b>	Returning Items for Repair Under Warranty or for Credit .....	73
Dell Support Center .....	53	Before You Call .....	74
My Dell Downloads .....	54	Contacting Dell .....	76
System Messages .....	55	<b>Finding More Information and Resources</b> .....	<b>78</b>
Hardware Troubleshooter .....	57	<b>Specifications</b> .....	<b>80</b>
Dell Diagnostics .....	58	<b>Appendix</b> .....	<b>88</b>
<b>Restoring Your Operating System</b> .....	<b>62</b>	Information for NOM, or Official Mexican Standard (Only for Mexico) .....	88
System Restore .....	63	<b>Index</b> .....	<b>89</b>
Dell DataSafe Local Backup .....	64		
System Recovery Media .....	66		
Dell Factory Image Restore .....	67		

# Setting Up Your Inspiron Laptop

This section provides information about setting up your Inspiron laptop.

## Before Setting Up Your Computer

When positioning your computer, ensure that you allow easy access to a power source, adequate ventilation, and a level surface to place your computer.

Restricting airflow around your Inspiron laptop may cause it to overheat. To prevent overheating ensure that you leave at least 10.2 cm (4 inches) at the back of the computer and a minimum of 5.1 cm (2 inches) on all other sides. You should never place your computer in an enclosed space, such as a cabinet or drawer when it is powered on.

 **WARNING:** Do not block, push objects into, or allow dust to accumulate in the air vents. Do not place your Dell™ computer in a low-airflow environment, such as a closed briefcase, while it is powered on. Restricting the airflow can damage the computer or cause a fire. The computer turns on the fan when the computer gets hot. Fan noise is normal and does not indicate a problem with the fan or the computer.

 **CAUTION:** Placing or stacking heavy or sharp objects on the computer may result in permanent damage to the computer.

## Connect the AC Adapter

Connect the AC adapter to the computer and then plug it into an electrical outlet or surge protector.

**⚠ WARNING:** The AC adapter works with electrical outlets worldwide. However, power connectors and power strips vary among countries. Using an incompatible cable or improperly connecting the cable to a power strip or electrical outlet may cause fire or permanent damage to your computer.

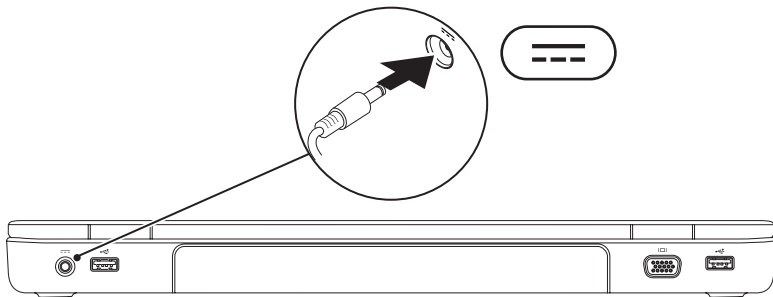



## Connect the Network Cable (Optional)

To use a wired network connection, connect the network cable.

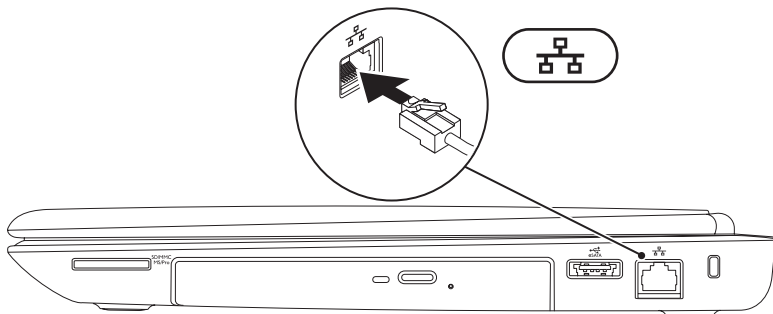

## Press the Power Button

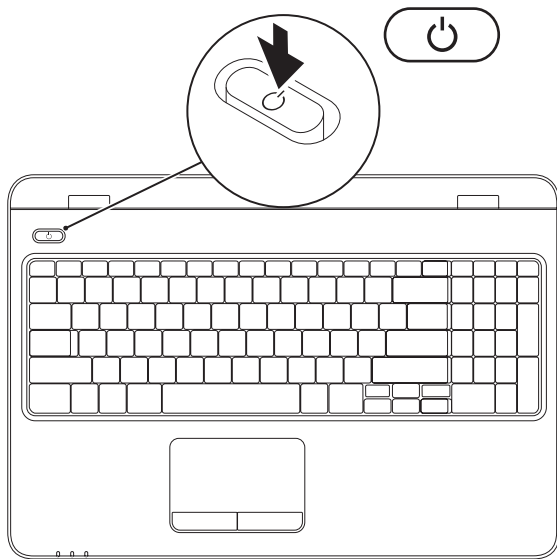



## Set Up the Operating System

Your Dell computer is preconfigured with the operating system you selected at the time of purchase.

### Set Up Microsoft Windows

To set up Microsoft® Windows® for the first time, follow the instructions on the screen. These steps are mandatory and may take some time to complete. The Windows setup screens will take you through several procedures including accepting license agreements, setting preferences, and setting up an Internet connection.

 **CAUTION:** Do not interrupt the operating system's setup process. Doing so may render your computer unusable and you will need to reinstall the operating system.

 **NOTE:** For optimal performance of your computer, it is recommended that you download and install the latest BIOS and drivers for your computer available at [support.dell.com](http://support.dell.com).

 **NOTE:** For more information on the operating system and features, see [support.dell.com/MyNewDell](http://support.dell.com/MyNewDell).

### Set Up Ubuntu

To set up Ubuntu® for the first time, follow the instructions on the screen. See the Ubuntu documentation for more operating system specific information.

# Create System Recovery Media (Recommended)

 **NOTE:** It is recommended that you create a system recovery media as soon as you set up Microsoft Windows.

The system recovery media can be used to restore your computer to the operating state it was in when you purchased the computer, while preserving data files (without the need of the *Operating System* disc). You can use the system recovery media if changes to the hardware, software, drivers, or other system settings have left the computer in an undesirable operating state.

You will require the following to create the system recovery media:

- Dell DataSafe Local Backup
- USB key with a minimum capacity of 8 GB or DVD-R/DVD+R/Blu-ray Disc™

 **NOTE:** Dell DataSafe Local Backup does not support rewritable discs.

To create a system recovery media:

1. Ensure that the AC adapter is connected (see “Connect the AC Adapter” on page 6).
2. Insert the disc or USB key in the computer.
3. Click **Start**  → **Programs** → **Dell DataSafe Local Backup**.
4. Click **Create Recovery Media**.
5. Follow the instructions on the screen.

 **NOTE:** For information on using the system recovery media, see “System Recovery Media” on page 66.

## Install the SIM Card (Optional)

 **CAUTION:** Do not insert a SIM card into the SIM card slot if you have not purchased a computer with a Mobile Broadband card. Doing so may render your computer unusable and you will need a service technician to fix the computer. Check your purchase invoice to see if you have purchased a Mobile Broadband card.

 **NOTE:** Installing a SIM is not required if you are using an EVDO card to access the Internet. Installing a Subscriber Identity Module (SIM) card on your computer allows you to connect to the Internet. To access the Internet you must be within the network of your cellular service provider.

To install the SIM card:

1. Turn off your computer.
2. Remove the battery (see “Removing and Replacing the Battery” on page 42).
3. In the battery bay, slide the SIM card into the SIM card slot.
4. Replace the battery (see “Removing and Replacing the Battery” on page 42).
5. Turn on your computer.

To remove the SIM card, press and eject the SIM card.

## Setting Up Your Inspiron Laptop

- 1 battery bay
- 2 SIM card
- 3 SIM card slot

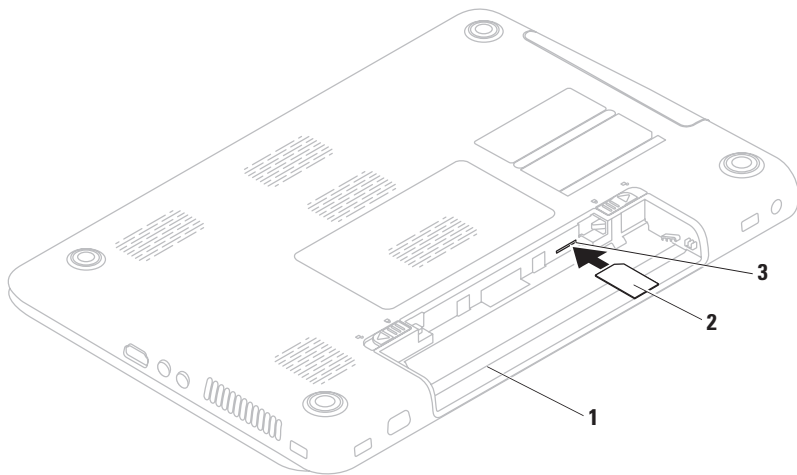

## Enable or Disable Wireless (Optional)

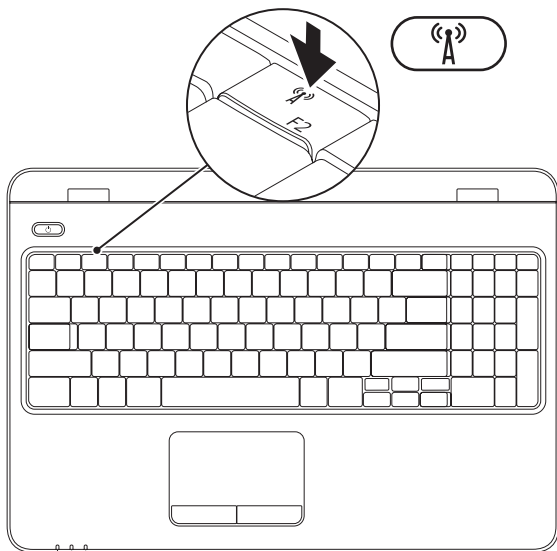



**NOTE:** The wireless feature is available on your computer only if you ordered a WLAN card at the time of purchase. For more information on the cards supported by your computer, see “Specifications” on page 80.

### To enable wireless:

1. Ensure that your computer is turned on.
2. Press the wireless key (A) on the function key row on the keyboard.  
A confirmation of your selection appears on the screen.

Wireless enabled



Wireless disabled



### To disable wireless:

Press the wireless key (A) on the function key row on the keyboard again to turn off all radios.

**NOTE:** The wireless key allows you to quickly turn off wireless radios (Wi-Fi and Bluetooth®), such as when you are asked to disable all wireless radios on an airplane flight.

# Set Up Wireless Display (Optional)

 **NOTE:** The wireless display feature may not be supported on all computers. For information about the hardware and software requirements for setting up wireless display, see [www.intel.com](http://www.intel.com).

The Intel® wireless display feature allows you to share your computer display to a TV without the use of cables. You must connect a wireless display adapter to your TV before setting up wireless display.

 **NOTE:** The wireless display adapter does not ship with your computer and must be purchased separately.

If your computer supports the wireless display feature, the Intel® Wireless Display  icon will be available on the Windows desktop.

To set up wireless display:

1. Ensure that your computer is turned on.
2. Ensure that wireless is enabled (see “Enable or Disable Wireless” on page 14).
3. Connect the wireless display adapter to the TV.
4. Turn on the TV.
5. Select the appropriate video source for your TV, such as HDMI1, HDMI2, or S-Video.
6. Click the Intel Wireless Display  icon on the desktop.  
The **Intel Wireless Display** window appears.
7. Select **Scan for available displays**.
8. Select your wireless display adapter from the **Detected wireless displays** list.
9. Enter the security code that appears on your TV.

To enable wireless display:

1. Click the Intel Wireless Display  icon on the desktop.  
The **Intel Wireless Display** window appears.

2. Select **Connect to Existing Adapter**.

 **NOTE:** The wireless display may get disconnected when you pair your computer with a Bluetooth device. To restore the wireless display, reconnect to the wireless display after the Bluetooth device is paired.

 **NOTE:** To download and install the latest driver for “Intel Wireless Display Connection Manager,” go to **[support.dell.com/support/downloads](http://support.dell.com/support/downloads)**.

 **NOTE:** For more information about wireless display, see the wireless display adapter documentation.

### Connect to the Internet (Optional)

To connect to the Internet, you need an external modem or network connection and an Internet Service Provider (ISP).

If an external USB modem or WLAN adapter is not a part of your original order, you can purchase one from the Dell website at [www.dell.com](http://www.dell.com).

### Setting Up a Wired Connection

- If you are using a dial-up connection, connect the telephone line to the optional external USB modem and to the telephone wall connector before you set up your Internet connection.
- If you are using a DSL or cable/satellite modem connection, contact your ISP or cellular telephone service for setup instructions.

To complete setting up your wired Internet connection, follow the instructions in “Setting Up Your Internet Connection” on page 20.

## Setting Up a Wireless Connection

 **NOTE:** To set up your wireless router, see the documentation that shipped with your router.

Before you can use your wireless Internet connection, you need to connect to your wireless router.

To set up your connection to a wireless router:

### *Windows Vista®*

1. Ensure that wireless is enabled on your computer (see “Enable or Disable Wireless” on page 14).
2. Save and close any open files, and exit any open programs.
3. Click **Start**  → **Connect To**.
4. Follow the instructions on the screen to complete the setup.

### *Windows® 7*

1. Ensure that wireless is enabled on your computer (see “Enable or Disable Wireless” on page 14).
2. Save and close any open files, and exit any open programs.
3. Click **Start**  → **Control Panel**.
4. In the search box, type `network`, and then click **Network and Sharing Center** → **Connect to a network**.
5. Follow the instructions on the screen to complete the setup.

### Setting Up Your Internet Connection

ISPs and ISP offerings vary by country. Contact your ISP for offerings available in your country.

If you cannot connect to the Internet but have successfully connected in the past, the ISP might have a service outage. Contact your ISP to check the service status, or try connecting again later.

Have your ISP information ready. If you do not have an ISP, the **Connect to the Internet** wizard can help you get one.

To set up your Internet connection:

*Windows Vista*<sup>®</sup>

1. Save and close any open files, and exit any open programs.
2. Click **Start**  → **Control Panel**.
3. In the search box, type `network`, and then click **Network and Sharing Center** → **Set up a connection or Network** → **Connect to the Internet**.

The **Connect to the Internet** window appears.

-  **NOTE:** If you do not know which type of connection to select, click **Help me choose** or contact your ISP.
4. Follow the instructions on the screen and use the setup information provided by your ISP to complete the setup.

*Windows® 7*

1. Save and close any open files, and exit any open programs.
2. Click **Start**  → **Control Panel**.
3. In the search box, type `network`, and then click **Network and Sharing Center** → **Set up a new connection or network** → **Connect to the Internet**.

The **Connect to the Internet** window appears.

-  **NOTE:** If you do not know which type of connection to select, click **Help me choose** or contact your ISP.
4. Follow the instructions on the screen and use the setup information provided by your ISP to complete the setup.

# Install Software Using Dell Digital Delivery

 **NOTE:** Dell Digital Delivery may not be available in all regions.



 **NOTE:** Dell Digital Delivery is supported only on Windows 7 operating systems.

Some of the software you purchased may not be pre-installed on your new computer. The Dell Digital Delivery application installed on your computer downloads and installs the software you purchased and completes the setup process.

 **NOTE:** If the Dell Digital Delivery application is not installed on your computer, you can download and install the application from [support.dell.com/support/downloads](http://support.dell.com/support/downloads).

The Dell Digital Delivery application launches automatically when you connect to the Internet after restarting your computer the first time. The application automatically identifies your hardware configuration, and then downloads and installs the software you have purchased.

You can also postpone downloads to a more convenient time or reinstall your software. You do not need to create a backup media of the software as the software can be downloaded at any time using the Dell Digital Delivery application.

To launch the Dell Digital Delivery application, click **Start**  → **All Programs** → **Dell** → **Dell Digital Delivery** or double-click the Dell Digital Delivery icon  in the notification area of your desktop.



To use Dell Digital Delivery:

1. Ensure that you are connected to the Internet (see “Connect to the Internet (Optional)” on page 18).
2. In the Dell Digital Delivery window, click **Download Now**.
3. Follow the instructions on the screen.

In most cases, the software download is completed in a few minutes. The duration of the download varies depending on the number of applications you purchased.



After the software installation is complete, the Dell Digital Delivery application notifies and prompts you to close the application window. The newly installed software can be accessed through the **Start**  menu.

# Using Your Inspiron Laptop

This section provides information about the features available on your Inspiron laptop.

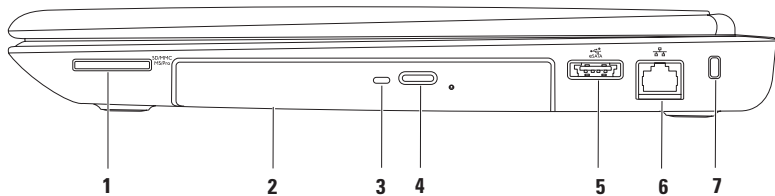



## Right View Features

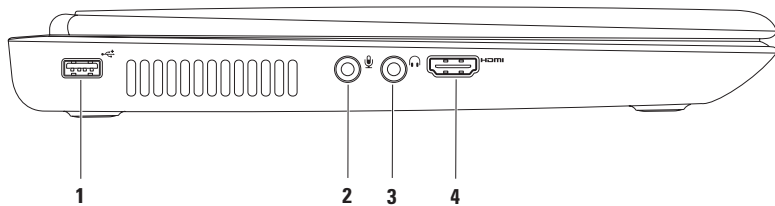

- 
- 1**  **7-in-1 Media Card Reader** — Provides a fast and convenient way to view and share digital photos, music, videos, and documents stored on memory cards.
- NOTE:** Your computer ships with a plastic blank installed in the media card slot. Blanks protect unused slots from dust and other particles. Save the blank for use when no media card is installed in the slot; blanks from other computers may not fit your computer.
- 
- 2** **Optical drive** — Plays or records CDs, DVDs, and Blu-ray Discs. For more information, see “Using the Optical Drive” on page 38.
- 
- 3** **Optical drive light** — Blinks when you press the optical drive eject button or when you insert a disc and it is being read.
- 
- 4** **Optical drive eject button** — Opens the optical drive tray when pressed.
- 
- 5**  **eSATA/USB combo connector** — Connects to eSATA compatible storage devices (such as external hard drives or optical drives) or USB devices (such as a mouse, keyboard, printer, external drive, or MP3 player).
- 
- 6**  **Network connector** — Connects your computer to a network or a broadband device if you are using a wired network.
- 
- 7** **Security cable slot** — Attaches a commercially available security cable to the computer.
- NOTE:** Before you buy a security cable, ensure that it fits into the security cable slot on your computer.
-

## Left View Features







-  **USB 2.0 connector** — Connects to USB devices, such as a mouse, keyboard, printer, external drive, or MP3 player.
  -  **Audio in/Microphone connector** — Connects to a microphone or inputs signal for use with audio programs.
  -  **Audio out/Headphone connector** — Connects to a pair of headphones or to a powered speaker or sound system.
  -  **HDMI connector** — Connects to a TV for both 5.1 audio and video signals.
- 

**NOTE:** When used with a monitor, only the video signal is read.

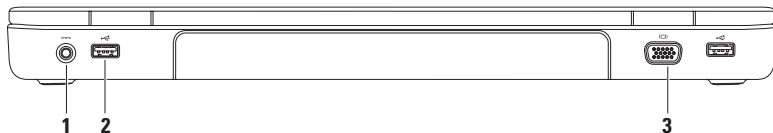
---

## Back View Features



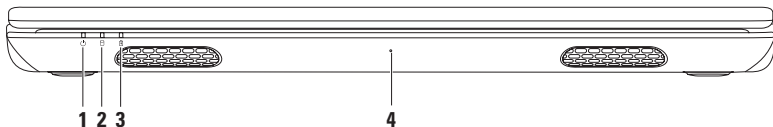

- 
- 1**  **AC adapter connector** — Connects to the AC adapter to power the computer and charge the battery.
- 
- 2**  **USB 2.0 connectors (2)** — Connect to USB devices, such as a mouse, keyboard, printer, external drive, or MP3 player.
- 
- 3**  **VGA connector** — Connects to a monitor or projector.
-

## Front View Features



- 
- 1**  **Power indicator light** — Indicates the power states. For more information on the power indicator light, see “Status Lights and Indicators” on page 30.

---

  - 2**  **Hard drive activity light** — Turns on when the computer reads or writes data. A solid white light indicates hard drive activity.  
 **CAUTION: To avoid loss of data, never turn off the computer when the hard drive activity light is on.**

---

  - 3**  **Battery status light** — Indicates the battery charge status. For more information on the battery status light, see “Status Lights and Indicators” on page 30.  
**NOTE:** The battery is charging when the computer is powered using the AC adapter.

---

  - 4** **Microphone** — Provides quality sound for video conferencing and voice recording.
-

## Status Lights and Indicators

### Battery Status Light

	Indicator light status	Computer state(s)	Battery charge level
<b>AC adapter</b>	solid white	on/standby/off/ hibernate	<= 98%
	off	on/standby/off/ hibernate	> 98%
<b>Battery</b>	solid amber	on/standby	<= 10%
	off	on/standby/off/ hibernate	>10%
		off/hibernate	<= 10%

 **NOTE:** The battery is charging when the computer is powered using the AC adapter.



## Power Button Light/Power Indicator Light

Indicator light status	Computer state(s)
solid white	on
breathing white	standby
off	off/hibernate

 **NOTE:** For information on power problems, see “Power Problems” on page 49.

## Computer Base and Keyboard Features

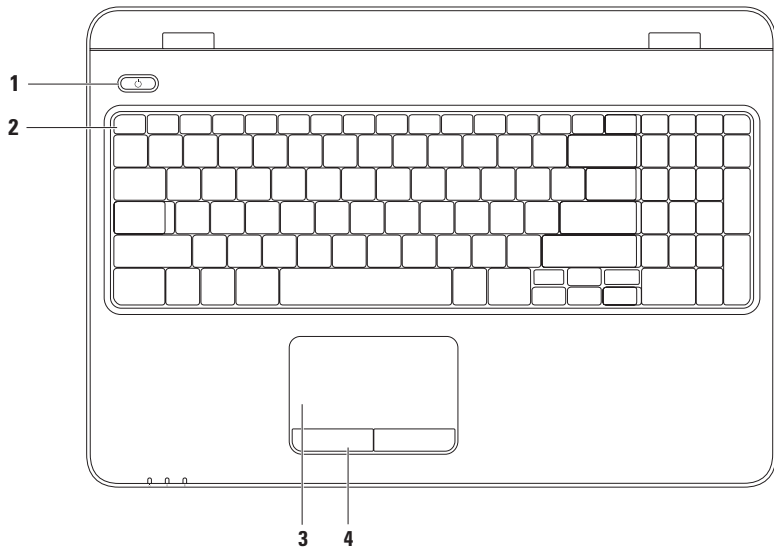

---

**1**  **Power button and light** — Turns the computer on or off when pressed. The light on the button indicates the power states. For more information on the power button light, see “Status Lights and Indicators” on page 30.

---

**2** **Function key row** — The wireless enable or disable key, brightness increase and decrease keys, multimedia keys, and the touch pad enable or disable key are located in this row. For more information on the multimedia keys, see “Multimedia Control Keys” on page 36.

---

**3** **Touch pad** — Provides the functionality of a mouse to move the cursor, drag or move selected items, and left-click by tapping the surface.

The touch pad supports the Scroll, Flick, Zoom, and Rotate features. To change the touch pad settings, double-click the **Dell Touch pad** icon in the notification area of the desktop. For more information, see “Touch Pad Gestures” on page 34.

**NOTE:** To enable or disable the touch pad, press the  key on the function key row on the keyboard.

---

**4** **Touch pad buttons (2)** — Provide left-click and right-click functions like those on a mouse.

---

## Touch Pad Gestures

### Scroll

Allows you to scroll through content. The scroll feature includes:

**Auto Scroll Vertical** — Allows you to scroll up or down on the active window.

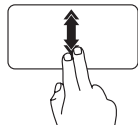

Move two fingers up or down at a fast pace to activate vertical auto scrolling.

Tap on the touch pad to stop auto scrolling.

**Auto Scroll Horizontal** — Allows you to scroll left or right on the active window.

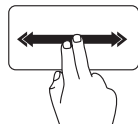

Move two fingers to your left or right at a fast pace to activate horizontal auto scrolling.

Tap on the touch pad to stop auto scrolling.

### Flick

Allows you to flip content forward or backward based on the direction of the flick.

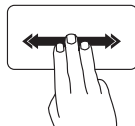

Move three fingers quickly in the desired direction to flip content in the active window.

## Zoom

Allows you to increase or decrease the magnification of the screen content. The zoom feature includes:

**Pinch** — Allows you to zoom in or zoom out by moving two fingers apart or bringing them closer together on the touch pad.

To zoom in:

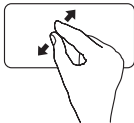

Move two fingers apart to enlarge the view of the active window.

To zoom out:

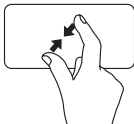

Move two fingers close together to reduce the view of the active window.

## Rotate

Allows you to rotate the active content on the screen. The rotate feature includes:

**Twist** — Allows you to rotate active content using two fingers where one finger is anchored and the other rotates.



Keeping the thumb in place, move the index finger in an arced direction right or left to rotate the selected item clockwise or counterclockwise.

## Multimedia Control Keys

The multimedia control keys are located on the function key row on the keyboard. To use the multimedia controls, press the required key. You can configure the multimedia control keys on the keyboard using the **System Setup (BIOS) Utility** or the **Windows Mobility Center**.

### System Setup (BIOS) Utility

1. Press <F2> during POST (Power On Self Test) to enter the System Setup (BIOS) utility.
2. In the **Function Key Behavior**, select **Multimedia Key First** or **Function Key First**.

**Multimedia Key First** — This is the default option. Press any multimedia key to perform the associated action. For function key, press <Fn> + the required function key.

**Function Key First** — Press any function key to perform the associated action. For multimedia key, press <Fn> + the required multimedia key.



**NOTE:** The **Multimedia Key First** option is active only in the operating system.

### Windows Mobility Center

1. Press the <  ><X> keys to launch the Windows Mobility Center.
2. In the **Function Key Row**, select **Function Key** or **Multimedia Key**.



---

 Mute the sound

---

 Decrease the volume level

---

 Increase the volume level

---

---

 Play the previous track or chapter

---

 Play or pause

---

 Play the next track or chapter

---

## Using the Optical Drive

 **CAUTION:** Do not press down on the optical drive tray when you open or close it. Keep the optical drive tray closed when you are not using the drive.

 **CAUTION:** Do not move the computer while playing or recording a disc.

This optical drive plays or records CDs, DVDs, and Blu-ray Discs. Ensure that the side with print or writing is facing upward when placing discs on the optical drive tray.

To place a disc in the optical drive:

1. Press the eject button on the optical drive.
2. Pull out the optical drive tray.
3. Place the disc, label side up, in the center of the optical drive tray and snap the disc onto the spindle.
4. Push the optical drive tray back into the drive.



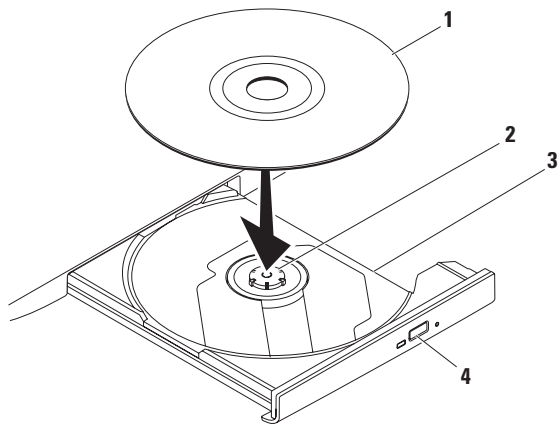

---

**1** disc

---

**2** spindle

---

**3** optical drive tray

---

**4** eject button

---

## Display Features

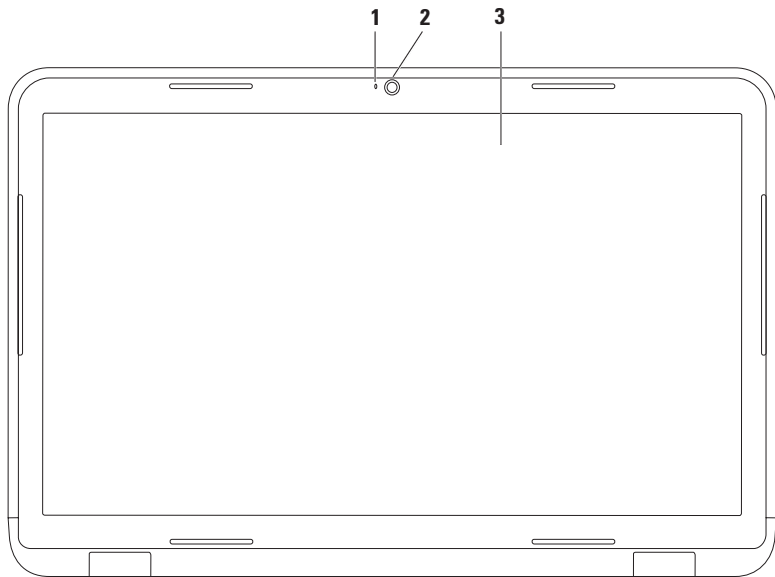

- 
- 1 Camera indicator light** — Turns on when the camera is active. A solid white light indicates camera activity.
  - 2 Camera** — Built-in camera for video capture, conferencing, and chat.
  - 3 Display** — Your display can vary based on selections you made when purchasing your computer. For more information about displays, see the *Dell Technology Guide* on your hard drive or at [support.dell.com/manuals](http://support.dell.com/manuals).
-

## Removing and Replacing the Battery



**WARNING:** Before you begin any of the procedures in this section, follow the safety instructions that shipped with your computer.



**WARNING:** Using an incompatible battery may increase the risk of fire or explosion. This computer should only use a battery purchased from Dell. Do not use batteries from other computers.



**WARNING:** Before removing the battery, shut down the computer, and remove external cables (including the AC adapter).

To remove the battery:

1. Turn off the computer and turn it over.
2. Slide the battery release latch and the battery lock latch to the unlock positions.
3. Slide and lift the battery out of the battery bay.

To replace the battery:

1. Align the tabs on the battery with the slots on the battery bay.
2. Slide the battery into the battery bay until it clicks into place.
3. Slide the battery lock latch to the lock position.

## Using Your Inspiron Laptop

- 1 battery lock latch
- 2 battery
- 3 battery release latch

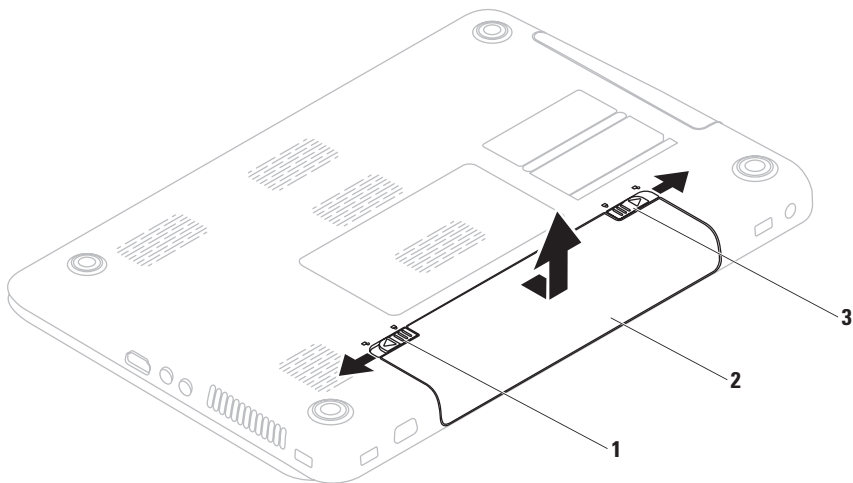

## Software Features

 **NOTE:** For more information about the features described in this section, see the *Dell Technology Guide* on your hard drive or at [support.dell.com/manuals](http://support.dell.com/manuals).

### FastAccess Facial Recognition

Your computer may have the FastAccess facial recognition feature. This feature helps keep your Dell computer secure by learning the unique appearance of your face and uses this to verify your identity to automatically supply login information when you would normally enter this information yourself (such as for logging into a Windows account or into secure websites).

For more information, click

**Start**  → **Programs** → **FastAccess**.

### Productivity and Communication

You can use your computer to create presentations, brochures, greeting cards, fliers, and spreadsheets. You can also edit and view digital photographs and images. Check your purchase order for software installed on your computer.

After connecting to the Internet, you can access websites, setup an e-mail account, and upload or download files.

## Entertainment and Multimedia

You can use your computer to watch videos, play games, create your own CDs/DVDs, listen to music and Internet radio stations.

You can download or copy pictures and video files from portable devices, such as digital cameras and cell phones. Optional software applications enable you to organize and create music and video files that can be recorded to disc, saved on portable products such as MP3 players and handheld entertainment devices, or played and viewed directly on connected TVs, projectors, and home theater equipment.

## Dell DataSafe Online Backup

 **NOTE:** Dell DataSafe Online is not supported by Linux operating systems.

 **NOTE:** A broadband connection is recommended for fast upload/download speeds.

Dell DataSafe Online is an automated backup and recovery service that helps protect your data and other important files from catastrophic incidents like theft, fire, or natural disasters. You can access the service on your computer using a password-protected account.

For more information, go to **[delldatasafe.com](http://delldatasafe.com)**.

To schedule backups:

1. Double-click the Dell DataSafe Online icon  on the taskbar.
2. Follow the instructions that appear on the screen.

# Dell Dock

The Dell Dock is a group of icons that provides easy access to frequently-used applications, files, and folders. You can personalize the Dock by:

- Adding or removing icons
- Changing the color and location of the Dock
- Grouping related icons into categories
- Changing the behavior of the icons



## Add a Category

1. Right-click the Dock, click **Add**→ **Category**. The **Add/Edit Category** window is displayed.
2. Enter a title for the category in the **Title** field.
3. Select an icon for the category from the **Select an image:** box.
4. Click **Save**.

## Add an Icon

Drag and drop the icon to the Dock or a category.

## Remove a Category or Icon

1. Right-click the category or icon on the Dock and click **Delete shortcut** or **Delete category**.
2. Follow the instructions on the screen.

## Personalize the Dock

1. Right-click the Dock and click **Advanced Setting....**
2. Choose the desired option to personalize the Dock.



# Solving Problems

This section provides troubleshooting information for your computer. If you cannot solve your problem using the following guidelines, see “Using Support Tools” on page 53 or “Contacting Dell” on page 76.

 **WARNING:** Only trained service personnel should remove the computer cover. See the *Service Manual* at [support.dell.com/manuals](http://support.dell.com/manuals) for advanced service instructions.

## Beep Codes

Your computer might emit a series of beeps during start-up if there are errors or problems. This series of beeps, called a beep code, identifies a problem. Write down the beep code and contact Dell (see “Contacting Dell” on page 76).

 **NOTE:** To replace parts, see the *Service Manual* at [support.dell.com](http://support.dell.com).

Beep Code	Possible Problem
One	Possible system board failure — BIOS ROM checksum failure
Two	No RAM detected <b>NOTE:</b> If you installed or replaced the memory module, ensure that the memory module is seated properly.
Three	Possible system board failure — Chipset error
Four	RAM read/write failure
Five	Real Time Clock failure
Six	Video card or chip failure
Seven	Processor failure
Eight	Display failure

# Network Problems

## Wireless Connections

### **If the wireless network connection is lost** —

The wireless router is offline or wireless has been disabled on the computer.

- Check if wireless is enabled on the computer (see “Enable or Disable Wireless” on page 14).
- Check your wireless router to ensure it is powered on and connected to your data source (cable modem or network hub).
- Re-establish your connection to the wireless router (see “Setting Up a Wireless Connection” on page 19).
- Interference may be blocking or interrupting your wireless connection. Try moving the computer closer to your wireless router.

## Wired Connections

**If the wired network connection is lost** — The cable is loose or damaged.

- Check the cable to ensure it is plugged in and not damaged.

## Power Problems

**If the power indicator light is off** — The computer is either turned off, in hibernate mode, or is not receiving power.

- Press the power button. The computer resumes normal operation if it is off or in hibernate mode.
- Reseat the AC adapter into both the power connector on the computer and the electrical outlet.
- If the AC adapter is plugged into a power strip, ensure that the power strip is plugged into an electrical outlet and that the power strip is turned on. Also bypass power protection devices, power strips, and power extension cables to verify that the computer turns on properly.
- Ensure that the electrical outlet is working by testing it with another device, such as a lamp.

- Check the AC adapter cable connections. If the AC adapter has a light, ensure that the light on the AC adapter is on.

**If the power indicator light is solid white and the computer is not responding** — The display may not be responding. Press the power button until the computer turns off and then turn it back on.

**If the power indicator light is breathing white** — The computer is in standby mode. Move the pointer using the connected mouse or press the power button to resume normal operation.

**If you encounter interference that hinders reception on your computer** — An unwanted signal is creating interference by interrupting or blocking other signals. Some possible causes of interference are:

- Power, keyboard, and mouse extension cables.
- Too many devices connected to a power strip.
- Multiple power strips connected to the same electrical outlet.

## Memory Problems

**If you receive an insufficient memory message** —

- Save and close any open files and exit any open programs you are not using to see if that resolves the problem.
- See the software documentation for minimum memory requirements. If necessary, install additional memory (see the *Service Manual* at [support.dell.com/manuals](http://support.dell.com/manuals)).
- Reseat the memory module(s) into the connector(s) (see the *Service Manual* at [support.dell.com/manuals](http://support.dell.com/manuals).)
- If the problem persists, contact Dell (see “Contacting Dell” on page 76).

**If you experience other memory problems** —

- Run the Dell Diagnostics (see “Dell Diagnostics” on page 58).
- If the problem persists, contact Dell (see “Contacting Dell” on page 76).

## Lockups and Software Problems

**If the computer does not start up** — Ensure that the AC adapter is firmly connected to the computer and to the electrical outlet.

**If a program stops responding** —

End the program:

1. Press <Ctrl><Shift><Esc> simultaneously.
2. Click **Applications**.
3. Select the program that is no longer responding
4. Click **End Task**.

**If a program crashes repeatedly** — Check the software documentation. If necessary, uninstall and then reinstall the program.



**NOTE:** Software usually includes installation instructions in its documentation or on the CD.

**If the computer stops responding or a solid blue screen appears —**

 **CAUTION: You might lose data if you are unable to perform an operating system shutdown.**

If you are unable to get a response by pressing a key on your keyboard or moving your mouse, press the power button for at least 8 to 10 seconds until the computer turns off and then restart your computer.

**If a program is designed for an earlier Microsoft® Windows® operating system —**

Run the Program Compatibility Wizard. The Program Compatibility Wizard configures a program so that it runs in an environment similar to an earlier version of Microsoft Windows operating system environments.

To run the Program Compatibility Wizard:

*Windows Vista®*

1. Click **Start**  → **Control Panel** → **Programs** → **Use an older program with this version of Windows.**
2. In the welcome screen, click **Next**.
3. Follow the instructions on the screen.

*Windows® 7*

1. Click **Start**  → **Control Panel** → **Programs** → **Run programs made for previous versions of Windows.**
2. In the welcome screen, click **Next**.
3. Follow the instructions on the screen.

## Solving Problems

### If a software you purchased is not available on your computer —

- Verify if the application(s) shortcut is available at **Start**  → **All Programs**.
- If the shortcut is not available, you can download and install the software you purchased using the Dell Digital Delivery application. For more information, see “Install Software Using Dell Digital Delivery” on page 22.

### If you have other software problems —

- Back up your files immediately.
- Use a virus-scanning program to check the hard drive or CDs.
- Save and close any open files or programs and shut down your computer through the **Start**  menu.
- Check the software documentation or contact the software manufacturer for troubleshooting information:

- Ensure that the program is compatible with the operating system installed on your computer.
- Ensure that your computer meets the minimum hardware requirements needed to run the software. See the software documentation for information.
- Ensure that the program is installed and configured properly.
- Verify that the device drivers do not conflict with the program.
- If necessary, uninstall and then reinstall the program.

# Using Support Tools

## Dell Support Center

**All the support you need – one convenient location.**

The **Dell Support Center** provides system alerts, performance improvement offers, system information, and links to other Dell tools and diagnostic services.

To launch the application, click **Start**  → **All Programs** → **Dell** → **Dell Support Center** → **Launch Dell Support Center**.

The **Dell Support Center** home page displays your computer's model number, service tag, express service code, warranty status, and alerts on improving the performance of your computer.

The home page also provides links to access:

**PC Checkup** — Run hardware diagnostics, see which program occupies the maximum memory on your hard drive, and track the changes made to your computer each day.

### PC Checkup Utilities

- **Drive Space Manager** — Manage your hard drive using a visual representation of space consumed by each type of file.
- **Performance and Configuration History** — Monitor system events and changes over time. This utility displays all hardware scans, tests, system changes, critical events and restoration points on the day they occurred.

**Detailed System Information** — View detailed information about your hardware and operating system configurations; access copies of your service contracts, warranty information, and warranty renewal options.

## Using Support Tools

**Get Help** — View Dell Technical Support options, Customer Support, Tours and Training, Online Tools, Owner's Manual, Warranty Information, FAQs, and so on.

**Backup and Recovery** — Create recovery media, launch recovery tool, and online file backup.

**System Performance Improvement Offers** — Acquire software and hardware solutions that will help improve your system performance.

For more information about **Dell Support Center** and to download and install the available support tools, go to **DellSupportCenter.com**.

## My Dell Downloads

 **NOTE:** My Dell Downloads may not be available in all regions.

Some of the drivers and software pre-installed on your new computer do not include a backup CD or DVD. This software is available at My Dell Downloads. From this website you can download available software for reinstallation or create your own backup media.

To register and use My Dell Downloads:

1. Go to **downloadstore.dell.com/media**.
2. Follow the instructions on the screen to register and download the software.
3. Reinstall or create backup media of the software for future use.

 **NOTE:** If you have purchased any additional software, you can download the software using Dell Digital Delivery. For more information, see "Install Software Using Dell Digital Delivery" on page 22.



## System Messages

If your computer has an issue or error, it may display a System Message that will help you identify the cause and action needed to resolve the issue.

 **NOTE:** If the message you received is not listed in the following examples, see the documentation for either the operating system or the program that was running when the message appeared. Alternatively you could see the *Dell Technology Guide* on your hard drive or at [support.dell.com](http://support.dell.com) or see “Contacting Dell” on page 76 for assistance.

**Alert! Previous attempts at booting this system have failed at checkpoint [nnnn]. For help in resolving this problem, please note this checkpoint and contact Dell Technical Support** — The computer failed to complete the boot routine three consecutive times for the same error. Contact Dell (see “Contacting Dell” on page 76).

**CMOS checksum error** — Possible system board failure or RTC battery low. Replace the battery (see the *Service Manual* at [support.dell.com/manuals](http://support.dell.com/manuals)) or Contact Dell (see “Contacting Dell” on page 76).

**CPU fan failure** — CPU fan has failed. Replace the CPU fan (see the *Service Manual* at [support.dell.com](http://support.dell.com)).

## Using Support Tools

**Hard-disk drive failure** — Possible hard-disk drive failure during POST. Contact Dell (see “Contacting Dell” on page 76).

**Hard-disk drive read failure** — Possible hard-disk drive failure during HDD boot test. Contact Dell (see “Contacting Dell” on page 76).

**Keyboard failure** — Keyboard failure or loose cable.

To replace the keyboard, see the *Service Manual* at [support.dell.com/manuals](http://support.dell.com/manuals).

**No boot device available** — No bootable partition on hard drive, the hard drive cable is loose, or no bootable device exists.

- If the hard drive is your boot device, ensure that the cables are connected and that the drive is installed properly and partitioned as a boot device.
- Enter system setup and ensure that the boot sequence information is correct (see the *Dell Technology Guide* on your hard drive or at [support.dell.com/manuals](http://support.dell.com/manuals)).

**No timer tick interrupt** — A chip on the system board might be malfunctioning or there might be a system board failure. Contact Dell (see “Contacting Dell” on page 76).

**USB over current error** — Disconnect the USB device. Your USB device needs more power for it to function properly. Use an external power source to connect the USB device, or if your device has two USB cables, connect both of them.

**CAUTION - Hard Drive SELF MONITORING SYSTEM has reported that a parameter has exceeded its normal operating range. Dell recommends that you back up your data regularly. A parameter out of range may or may not indicate a potential hard drive problem** — S.M.A.R.T error, possible hard drive failure. Contact Dell (see “Contacting Dell” on page 76).

## Hardware Troubleshooter

If a device is either not detected during the operating system setup or is detected but incorrectly configured, you can use the **Hardware Troubleshooter** to resolve the incompatibility.

To start the Hardware Troubleshooter:

1. Click **Start**  → **Help and Support**.
2. Type `hardware troubleshooter` in the search field and press <Enter> to start the search.
3. In the search results, select the option that best describes the problem and follow the remaining troubleshooting steps.

### Dell Diagnostics

If you experience a problem with your computer, perform the checks in “Lockups and Software Problems” on page 50 and run the Dell Diagnostics before you contact Dell for technical assistance.

 **NOTE:** Dell Diagnostics works only on Dell computers.

 **NOTE:** The *Drivers and Utilities* disc may not ship with your computer.

Ensure that the device that you want to test displays in the system setup program and is active. Press <F2> during POST (Power On Self Test) to enter the System Setup (BIOS) utility.

Start the Dell Diagnostics from your hard drive or from the *Drivers and Utilities* disc.

### Starting Dell Diagnostics From Your Hard Drive

The Dell Diagnostics is located on a hidden diagnostic utility partition on your hard drive.

 **NOTE:** If your computer cannot display a screen image, contact Dell (see “Contacting Dell” on page 76).

1. Ensure that the computer is connected to an electrical outlet that is known to be working properly.
2. Turn on (or restart) your computer.
3. When the DELL™ logo appears, press <F12> immediately. Select **Diagnostics** from the boot menu and press <Enter>. This may invoke the Pre-Boot System Assessment (PSA) on your computer.

 **NOTE:** If you wait too long and the operating system logo appears, continue to wait until you see the Microsoft® Windows® desktop; then, shut down your computer and try again.

 **NOTE:** If you see a message stating that no diagnostics utility partition has been found, run the Dell Diagnostics from the *Drivers and Utilities* disc.

*If PSA is invoked:*

- a. The PSA will start running tests.
- b. If the PSA completes successfully, the following message is displayed: `"No problems have been found with this system so far. Do you want to run the remaining memory tests? This will take about 30 minutes or more. Do you want to continue? (Recommended)."`

- c. If you are experiencing memory issues, press <y>, otherwise press <n>. The following message is displayed: `"Booting Dell Diagnostic Utility Partition. Press any key to continue."`
- d. Press any key to go to the **Choose An Option** window.

*If PSA is not invoked:*



Press any key to start the Dell Diagnostics from the diagnostic utility partition on your hard drive and to go to the **Choose An Option** window.

4. Select the test you want to run.

## Using Support Tools

5. If you encounter a problem during a test, a message with the error code and a description of the problem will appear on your screen. Write down the error code and problem description and contact Dell (see “Contacting Dell” on page 76).
-  **NOTE:** The Service Tag for your computer is displayed at the top of each test screen. The Service Tag helps you identify your computer when you contact Dell.
6. When the tests complete, close the test screen to return to the **Choose An Option** window.
7. To exit the Dell Diagnostics and to restart the computer, click **Exit**.

## Starting Dell Diagnostics From the Drivers and Utilities Disc

-  **NOTE:** The *Drivers and Utilities* disc may not ship with your computer.
1. Insert the *Drivers and Utilities* disc.
  2. Shut down and restart the computer. When the DELL™ logo appears, press <F12> immediately.
-  **NOTE:** If you wait too long and the operating system logo appears, continue to wait until you see the Microsoft® Windows® desktop; then, shut down your computer and try again.
  -  **NOTE:** The next steps change the boot sequence for one time only. On the next start-up, the computer boots according to the devices specified in the system setup program.

3. When the boot device list appears, highlight **CD/DVD/CD-RW** and press <Enter>.
  4. Select the **Boot from CD-ROM** option from the menu that appears and press <Enter>.
  5. Type 1 to start the CD menu and press <Enter> to proceed.
  6. Select **Run the 32 Bit Dell Diagnostics** from the numbered list. If multiple versions are listed, select the version appropriate for your computer.
  7. Select the test you want to run.
  8. If you encounter a problem during a test, a message with the error code and a description of the problem will appear on your screen. Write down the error code and problem description and contact Dell (see “Contacting Dell” on page 76).
-  **NOTE:** The Service Tag for your computer is displayed at the top of each test screen. The Service Tag helps you identify your computer when you contact Dell.
9. When the tests complete, close the test screen to return to the **Choose An Option** window.
  10. To exit the Dell Diagnostics and restart the computer, click **Exit**.
  11. Remove the *Drivers and Utilities* disc.

# Restoring Your Operating System

You can restore the operating system on your computer using any of the following options:

 **CAUTION:** Using Dell Factory Image Restore or the *Operating System* disc permanently deletes all data files on your computer. If possible, backup your data files before using these options.

Option	Use
System Restore	as the first solution
Dell DataSafe Local Backup	when System Restore does not resolve your problem
System recovery media	when operating system failure prevents the use of System Restore and DataSafe Local Backup when installing the factory image on a newly installed hard drive
Dell Factory Image Restore	to restore your computer to the operating state it was in when you received your computer
<i>Operating System</i> disc	to reinstall only the operating system on your computer

 **NOTE:** After restoring your operating system, the Dell Digital Delivery application automatically downloads and installs the software you purchased with your computer. If the Dell Digital Delivery application is not installed on your computer, you can download and install the application from [support.dell.com](http://support.dell.com). For more information, see “Install Software Using Dell Digital Delivery” on page 22.





## System Restore

The Windows operating systems provide a System Restore option which allows you to return your computer to an earlier operating state (without affecting data files) if changes to the hardware, software, or other system settings have left the computer in an undesirable operating state. Any changes that System Restore makes to your computer are completely reversible.

 **CAUTION: Make regular backups of your data files. System Restore does not monitor your data files or recover them.**

### Starting System Restore

1. Click **Start** .
2. In the search box, type `System Restore` and press <Enter>.

 **NOTE:** The **User Account Control** window may appear. If you are an administrator on the computer, click **Continue**; otherwise, contact your administrator to continue the desired action.

3. Click **Next** and follow the instructions on the screen.

In the event that System Restore did not resolve the issue, you may undo the last system restore.

### Undoing the Last System Restore

 **NOTE:** Before you undo the last system restore, save and close all open files, and exit any open programs. Do not alter, open, or delete any files or programs until the system restoration is complete.

1. Click **Start** .
2. In the search box, type `System Restore` and press <Enter>.
3. Click **Undo my last restoration** and click **Next**.

### Dell DataSafe Local Backup

 **CAUTION:** Using Dell DataSafe Local Backup permanently removes any programs or drivers installed after you received your computer. Prepare backup media of applications you need to install on your computer before using Dell DataSafe Local Backup. Use Dell DataSafe Local Backup only if System Restore did not resolve your operating system problem.

 **CAUTION:** Although Dell Datasafe Local Backup is designed to preserve the data files on your computer, it is recommended that you backup your data files before using the Dell DataSafe Local Backup.

 **NOTE:** Dell DataSafe Local Backup may not be available in all regions.

 **NOTE:** If Dell DataSafe Local Backup is not available on your computer, use Dell Factory Image Restore (see “Dell Factory Image Restore” on page 67) to restore your operating system.

You can use Dell DataSafe Local Backup to restore your hard drive to the operating state it was in when you purchased your computer, while preserving the data files.

Dell DataSafe Local Backup allows you to:

- Backup and restore your computer to an earlier operating state
- Create system recovery media

### Dell DataSafe Local Backup Basic

To restore the factory image while preserving the data files:

1. Turn off your computer.
2. Disconnect all the devices (USB drive, printer, etc.) connected to the computer and remove any newly added internal hardware.

 **NOTE:** Do not disconnect the display, keyboard, mouse, or the power cable.

3. Turn on your computer.

4. When the DELL™ logo appears, press <F8> several times to access the **Advanced Boot Options** window.

 **NOTE:** If you wait too long and the operating system logo appears, continue to wait until you see the Microsoft® Windows® desktop; then, shut down your computer and try again.

5. Select **Repair Your Computer**.

6. Select **Dell DataSafe Restore and Emergency Backup** from the **System Recovery Options** menu and follow the instructions on the screen.

 **NOTE:** The restoration process might take an hour or more depending on the size of the data to be restored.

 **NOTE:** For more information, see the knowledge base article 353560 at [support.dell.com](http://support.dell.com).

## Upgrading to Dell DataSafe Local Backup Professional

 **NOTE:** Dell DataSafe Local Backup Professional may be installed on your computer, if you ordered it at the time of purchase.

Dell DataSafe Local Backup Professional provides additional features that allow you to:

- Backup and restore your computer based on file types
- Backup files to a local storage device
- Schedule automated backups

To upgrade to Dell DataSafe Local Backup Professional:

1. Double-click the Dell DataSafe Local Backup icon  on the taskbar.
2. Click **UPGRADE NOW!**
3. Follow the instructions on the screen to complete the upgrade.

# System Recovery Media

 **CAUTION:** Although the system recovery media is designed to preserve the data files on your computer, it is recommended that you backup your data files before using the system recovery media.

You can use the system recovery media, created using Dell DataSafe Local Backup, to return your hard drive to the operating state it was in when you purchased the computer while persevering the data files on your computer.

Use the system recovery media in case of:

- Operating system failure that prevents the use of recovery options that are installed on your computer.
- Hard drive failure that prevents data from being recovered.

To restore the factory image of your computer using the system recovery media:

1. Insert the system recovery disc or USB key and restart the computer.
2. When the DELL™ logo appears, press <F12> immediately.

 **NOTE:** If you wait too long and the operating system logo appears, continue to wait until you see the Microsoft® Windows® desktop; then, shut down your computer and try again.

3. Select the appropriate boot device from the list and press <Enter>.
4. Follow the instructions on the screen to complete the recovery process.

## Dell Factory Image Restore

 **CAUTION:** Using Dell Factory Image Restore permanently deletes all data on the hard drive and removes any programs or drivers installed after you received your computer. If possible, back up the data before using this option. Use Dell Factory Image Restore only if System Restore did not resolve your operating system problem.

 **NOTE:** Dell Factory Image Restore may not be available in certain countries or on certain computers.

 **NOTE:** If Dell Factory Image Restore is not available on your computer, use Dell DataSafe Local Backup (see “Dell DataSafe Local Backup” on page 64) to restore your operating system.

Use Dell Factory Image Restore only as the last method to restore your operating system. This option restores your hard drive to the operating state it was in when you purchased the computer. Any programs or files added since you received your computer—including data files—are permanently deleted from the hard drive. Data files include documents, spreadsheets, e-mail messages, digital photos, music files, and so on. If possible, back up all data before using Dell Factory Image Restore.

### Starting Dell Factory Image Restore

1. Turn on the computer.
2. When the DELL logo appears, press <F8> several times to access the **Advanced Boot Options** window.

 **NOTE:** If you wait too long and the operating system logo appears, continue to wait until you see the Microsoft® Windows® desktop; then, shut down your computer and try again.

## Restoring Your Operating System

### 3. Select **Repair Your Computer**.

The **System Recovery Options** window appears.

### 4. Select a keyboard layout and click **Next**.

### 5. To access the recovery options, log on as a local user. To access the command prompt, type `administrator` in the **User name** field, then click **OK**.

### 6. Click **Dell Factory Image Restore**.

The **Dell Factory Image Restore** welcome screen appears.

 **NOTE:** Depending upon your configuration, you may need to select **Dell Factory Tools**, then **Dell Factory Image Restore**.

### 7. Click **Next**.

The **Confirm Data Deletion** screen appears.

 **NOTE:** If you do not want to proceed with Factory Image Restore, click **Cancel**.

### 8. Select the check box to confirm that you want to continue reformatting the hard drive and restoring the system software to the factory condition, then click **Next**.

The restore process begins and may take five or more minutes to complete. A message appears when the operating system and factory-installed applications have been restored to factory condition.

### 9. Click **Finish** to restart the computer.

# Getting Help

If you experience a problem with your computer, you can complete the following steps to diagnose and troubleshoot the problem:

1. See “Solving Problems” on page 47 for information and procedures that pertain to the problem your computer is experiencing.
2. See the *Dell Technology Guide* on your hard drive or at [support.dell.com/manuals](http://support.dell.com/manuals) for more troubleshooting information.
3. See “Dell Diagnostics” on page 58 for procedures on how to run Dell Diagnostics.
4. Fill out the “Diagnostic Checklist” on page 75.
5. Use Dell’s extensive suite of online services available at [support.dell.com](http://support.dell.com) for help with installation and troubleshooting procedures. See “Online Services” on page 71 for a more extensive list of Dell Support online.

6. If the preceding steps have not resolved the problem, see “Before You Call” on page 74.

 **NOTE:** Call Dell Support from a telephone near or at the computer so that the support staff can assist you with any necessary procedures.

 **NOTE:** Dell’s Express Service Code system may not be available in all countries.

When prompted by Dell’s automated telephone system, enter your Express Service Code to route the call directly to the proper support personnel. If you do not have an Express Service Code, open the **Dell Accessories** folder, double-click the **Express Service Code** icon, and follow the directions.

 **NOTE:** Some of the services are not always available in all locations outside the continental U.S. Call your local Dell representative for information on availability.

## Technical Support and Customer Service

Dell's support service is available to answer your questions about Dell hardware. Our support staff use computer-based diagnostics to provide fast, accurate answers.

To contact Dell's support service, see "Before You Call" on page 74 and then see the contact information for your region or go to **[support.dell.com](http://support.dell.com)**.

## DellConnect™

DellConnect is a simple online access tool that allows a Dell service and support associate to access your computer through a broadband connection, diagnose your problem and repair it all under your supervision. For more information, go to **[www.dell.com/dellconnect](http://www.dell.com/dellconnect)**.



## Online Services

You can learn about Dell products and services on the following websites:

- **www.dell.com**
- **www.dell.com/ap** (Asian/Pacific countries only)
- **www.dell.com/jp** (Japan only)
- **www.euro.dell.com** (Europe only)
- **www.dell.com/la** (Latin American and Caribbean countries)
- **www.dell.ca** (Canada only)

You can access Dell Support through the following websites and e-mail addresses:

### Dell Support websites

- **support.dell.com**
- **support.jp.dell.com** (Japan only)
- **support.euro.dell.com** (Europe only)
- **supportapj.dell.com** (Asia Pacific only)

### Dell Support e-mail addresses

- **mobile\_support@us.dell.com**
- **support@us.dell.com**
- **la-techsupport@dell.com** (Latin America and Caribbean countries only)
- **apsupport@dell.com** (Asian/Pacific countries only)

### Dell Marketing and Sales e-mail addresses

- **apmarketing@dell.com** (Asian/Pacific countries only)
- **sales\_canada@dell.com** (Canada only)

### Anonymous file transfer protocol (FTP)

- **ftp.dell.com**

Log in as user: `anonymous`, and use your e-mail address as your password.

## Automated Order-Status Service

To check on the status of any Dell products that you have ordered, you can go to **support.dell.com**, or you can call the automated order-status service. A recording prompts you for the information needed to locate and report on your order.

If you have a problem with your order, such as missing parts, wrong parts, or incorrect billing, contact Dell for customer assistance. Have your invoice or packing slip handy when you call.

For the telephone number to call for your region, see “Contacting Dell” on page 76.

## Product Information



If you need information about additional products available from Dell, or if you would like to place an order, visit the Dell website at **www.dell.com**. For the telephone number to call for your region or to speak to a sales specialist, see “Contacting Dell” on page 76.

## Returning Items for Repair Under Warranty or for Credit

Prepare all items being returned, whether for repair or credit, as follows:

 **NOTE:** Before you return the product to Dell, make sure to back up any data on the hard drive(s) and on any other storage device in the product. Remove any and all confidential, proprietary and personal information, as well as removable media, such as CDs and media cards. Dell is not responsible for any of your confidential, proprietary or personal information; lost or corrupted data; or damaged or lost removable media that may be included with your return.

1. Call Dell to obtain a Return Material Authorization Number, and write it clearly and prominently on the outside of the box. For the telephone number to call your region, see “Contacting Dell” on page 76.

2. Include a copy of the invoice and a letter describing the reason for the return.
3. Include a copy of the Diagnostics Checklist (see “Diagnostic Checklist” on page 75), indicating the tests that you have run and any error messages reported by the Dell Diagnostics (see “Dell Diagnostics” on page 58).
4. Include any accessories that belong with the item(s) being returned (power cables, software, guides, and so on) if the return is for credit.
5. Pack the equipment to be returned in the original (or equivalent) packing materials.  
 **NOTE:** You are responsible for paying shipping expenses. You are also responsible for insuring any product returned, and you assume the risk of loss during shipment to Dell. Collect On Delivery (C.O.D.) packages are not accepted.  
 **NOTE:** Returns that are missing any of the preceding requirements will be refused at Dell’s receiving dock and returned to you.

## Before You Call

- NOTE:** Have your Express Service Code ready when you call. The code helps Dell's automated-support telephone system direct your call more efficiently. You may also be asked for your Service Tag.

### Locating Your Service Tag

The Service Tag for your computer can be found on a label at the bottom of your computer.

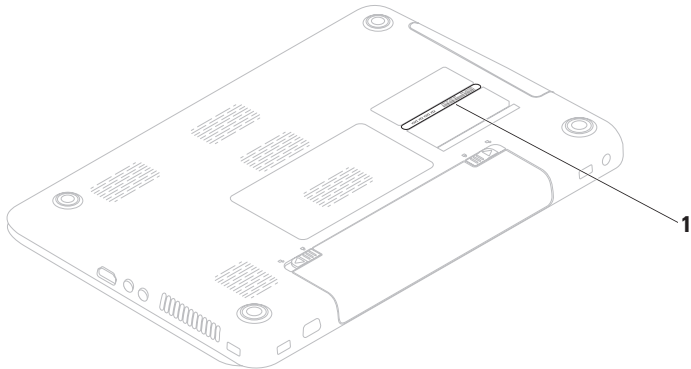

---

**1** Service Tag

---

Remember to fill out the following Diagnostic Checklist. If possible, turn on your computer before you call Dell for assistance and call from a telephone at or near the computer. You may be asked to type some commands at the keyboard, relay detailed information during operations, or try other troubleshooting steps possible only at the computer itself. Ensure that the computer documentation is available.

### **Diagnostic Checklist**

- Name:
- Date:
- Address:
- Phone number:
- Service Tag (bar code on the back or bottom of the computer):
- Express Service Code:
- Return Material Authorization Number (if provided by Dell support technician):
- Operating system and version:
- Devices:
- Expansion cards:
- Are you connected to a network? Yes/No
- Network, version, and network adapter:
- Programs and versions:

## Getting Help

See your operating system documentation to determine the contents of the computer's start-up files. If the computer is connected to a printer, print each file. Otherwise, record the contents of each file before calling Dell.

- Error message, beep code, or diagnostic code:
- Description of problem and troubleshooting procedures you performed:

## Contacting Dell

For customers in the United States, call 800-WWW-DELL (800-999-3355).

 **NOTE:** If you do not have an active Internet connection, you can find contact information on your purchase invoice, packing slip, bill, or Dell product catalog.

Dell provides several online and telephone-based support and service options. Availability varies by country and product, and some services may not be available in your area.

To contact Dell for sales, technical support, or customer service issues:

1. Visit **[www.dell.com/contactdell](http://www.dell.com/contactdell)**.
2. Select your country or region.
3. Select the appropriate service or support link based on your requirement.
4. Choose the method of contacting Dell that is convenient for you.



# Finding More Information and Resources

**If you need to:****See:**

---

reinstall your operating system

“System Recovery Media” on page 66

---

run a diagnostic program for your computer

“Dell Diagnostics” on page 58

---

reinstall laptop system software

“My Dell Downloads” on page 54

---

for more information about the Microsoft®  
Windows® operating system and features

**support.dell.com**

---

upgrade your computer with new or additional  
components like a new hard drive

the *Service Manual* at  
**support.dell.com/manuals**

---

reinstall or replace a worn or defective part



**NOTE:** In some countries, opening and replacing parts of your computer may void your warranty. Check your warranty and return policies before working inside your computer.

---



**If you need to:**

find safety best practices information for your computer

review Warranty information, Terms and Conditions (U.S. only), Safety instructions, Regulatory information, Ergonomics information, and End User License Agreement

find your Service tag/Express Service Code — You must use the service tag to identify your computer on **support.dell.com** or to contact technical support

find drivers and downloads; readme files  
access technical support and product help  
check on your order status for new purchases  
find solutions and answers to common questions  
locate information for last-minute updates about technical changes to your computer or advanced technical-reference material for technicians or experienced users

**See:**

the safety and regulatory documents that shipped with your computer and also see the Regulatory Compliance Homepage at **www.dell.com/regulatory\_compliance**



the bottom of your computer  
the **Dell Support Center**. To launch the **Dell Support Center**, click **Start**  → **All Programs** → **Dell** → **Dell Support Center** → **Launch Dell Support Center**.

**support.dell.com**

# Specifications

This section provides information that you may need when setting up, updating drivers for, and upgrading your computer.

For more information, see [support.dell.com/manuals](http://support.dell.com/manuals).

 **NOTE:** Offerings may vary by region. For more information regarding the configuration of your computer, click **Start**  → **Help and Support** and select the option to view information about your computer.

## Computer Model

---

Dell Inspiron N5010  
Dell Inspiron M5010

## System Chipset

---

Inspiron N5010	Mobile Intel 5 series express chipset HM57
Inspiron M5010	AMD™ RS880M AMD SB820M

## Processor

---

Inspiron N5010	Intel® Core™ i3 Intel Core i5 Intel Core i7 Intel Pentium®
Inspiron M5010	AMD Athlon™ II Dual-Core AMD Turion™ II Dual-Core AMD Phenom™ II Dual-Core AMD Phenom II Triple-Core AMD Phenom II Quad-Core

**Memory**

Memory module connector	two user-accessible SODIMM connectors
-------------------------	---------------------------------------

Memory type	SODIMM DDR3
-------------	-------------

Memory operating frequency:

**Inspiron N5010**

Intel Core i7 Dual-Core	1333 MHz
-------------------------	----------

Intel Pentium, Intel Core i3, and Intel Core i5 Dual-Core	1067 MHz
---	----------

**Inspiron M5010**

AMD Phenom	1333 MHz
------------	----------

AMD Athlon, AMD Turion, and AMD V-Series Single-Core	1067 MHz
--	----------

**Memory**

Memory module capacities	1 GB, 2 GB, and 4 GB
--------------------------	----------------------

Possible memory configurations	2 GB, 3 GB, 4 GB, 5 GB, 6 GB, and 8 GB
--------------------------------	--

**NOTE:** For instructions on upgrading the memory, see the *Service Manual* at [support.dell.com/manuals](http://support.dell.com/manuals).

**Communications**

Modem (optional)	External V.92 56K USB modem
------------------	-----------------------------

Network adapter	10/100 Ethernet LAN on system board
-----------------	-------------------------------------

Wireless	WLAN Wi-Fi g/gn/agn; WiMax/Wi-Fi agn; Bluetooth® wireless technology; WWAN
----------	--

## Specifications

### Connectors

---

Audio	one microphone-in connector, one stereo headphones/speakers connector
Mini-Card	one half Mini-Card slot
HDMI	one 19-pin connector
Network	one RJ45 connector
USB	three 4-pin USB 2.0-compliant connectors
VGA	one 15-hole connector
eSATA	one 7-pin/4-pin eSATA/USB combo connector
Media card reader	one 7-in-1 slot

### Media Card Reader

---

Cards supported	Secure Digital (SD) memory card Secure Digital High Capacity (SDHC) Memory Stick Memory Stick PRO MultiMedia Card (MMC) MMC+ xD-Picture Card
-----------------	--

### Audio

---

Audio controller	IDT-92HD79B1
Speakers	2 x 2 Watt
Volume controls	software program menus and media controls

**Video**

Inspiron N5010:

Discrete

Video controller	ATI Mobility Radeon™ HD 5470 ATI Mobility Radeon HD 550v ATI Mobility Radeon HD 5650
------------------	--

Video memory	DDR3 512 MB/1 GB DDR3 1 GB
--------------	-------------------------------

UMA

Video controller	Intel® HD Graphics
------------------	--------------------

Video memory	up to 1752 MB of shared memory
--------------	--------------------------------

**Video**

Inspiron M5010:

Discrete

Video controller	ATI Mobility Radeon HD 550v
------------------	-----------------------------

Video memory	DDR3 1GB
--------------	----------

UMA

Video controller	ATI Mobility Radeon HD 4250
------------------	-----------------------------

Video memory	up to 3067 MB of shared memory
--------------	--------------------------------

**Camera**

Pixel	1.3 megapixel
-------	---------------

Video resolution	640 x 480 at 30 fps
------------------	---------------------

## Specifications

### Display

---

Type	15.6" HD WLED backlight, TrueLife
Dimensions:	
Height	193.54 mm (7.62 inches)
Width	344.23 mm (13.55 inches)
Diagonal	396.42 mm (15.6 inches)
Maximum resolution	1366 x 768
Refresh rate	60 Hz
Operating angle	0° (closed) to 135°
Horizontal viewing angle	40/40
Vertical viewing angle	15/30 (H/L)
Pixel pitch	0.252 x 0.252 mm

### Keyboard

---

Number of keys	102 (U.S. and Canada); 103 (Europe); 106 (Japan); 105 (Brazil)
----------------	--

### Touch Pad

---

Width	90.0 mm (3.54 inches) sensor-active area
Height	45.2 mm (1.78 inches) rectangle

**Battery**

9-cell "smart" lithium ion

Height	22.80 mm (0.9 inches)
Width	214 mm (8.43 inches)
Depth	78.76 mm (3.10 inches)
Weight	0.52 kg (1.15 lb)

6-cell "smart" lithium ion

Height	22.80 mm (0.9 inches)
Width	214 mm (8.43 inches)
Depth	57.64 mm (2.27 inches)
Weight	0.34 kg (0.75 lb)
Voltage	11.1 VDC (6/9 cell)
Charge time (approximate)	4 hours (when the computer is turned off)

**Battery**

Operating time	Battery operating time varies depending on operating conditions.
Coin-cell battery	CR-2032

**AC Adapter**

 **NOTE:** Use only AC adapters specified for use with your computer. See the safety information that shipped with your computer.

Input voltage	100–240 VAC
Input current (maximum)	
65 W/90 W	1.7 A
130 W	2.5 A
Input frequency	50–60 Hz
Output power	65 W or 90 W or 130 W

## Specifications

### AC Adapter

---

Output current	
65 W	3.34 A (continuous)
90 W	4.62 A (continuous)
130 W	6.7 A (continuous)
Rated output voltage	19.5 VDC
Operating temperature	0° to 40°C (32° to 104°F)
Storage temperature	-40° to 70°C (-40° to 158°F)

### Physical

---

Height	31.8 mm to 34 mm (1.25 inches to 1.34 inches)
Width	376 mm (14.8 inches)
Depth	262 mm (10.31 inches)
Weight (with 6-cell battery)	configurable to less than 2.7 kg (5.95 lb)



## Computer Environment

---

Temperature range:

Operating	0° to 35°C (32° to 95°F)
Storage	-40° to 65°C (-40° to 149°F)

Relative humidity (maximum):

Operating	10% to 90% (noncondensing)
Storage	5% to 95% (noncondensing)

Maximum vibration (using a random vibration spectrum that simulates user environment):

Operating	0.66 GRMS
Non-Operating	1.30 GRMS

## Computer Environment

---

Maximum shock (for operating — measured with Dell Diagnostics running on the hard drive and a 2-ms half-sine pulse; for non-operating — measured with hard drive in head-parked position and a 2-ms half-sine pulse):

Operating	110 G
Non-Operating	160 G

Altitude (maximum):

Operating	-15.2 to 3048 m (-50 to 10,000 ft)
Storage	-15.2 to 10,668 m (-50 to 35,000 ft)

Airborne contaminant level G2 or lower as defined by ISA-S71.04-1985

# Appendix

## Information for NOM, or Official Mexican Standard (Only for Mexico)

The following information is provided in the device(s) described in this document in accordance with the requirements of the Official Mexican Standard (NOM):

### Importer:

Dell México S.A. de C.V.

Paseo de la Reforma 2620 – Flat 11°

Col. Lomas Altas

11950 México, D.F.

<b>Regulatory model number</b>	<b>Voltage</b>	<b>Frequency</b>	<b>Electricity consumption</b>	<b>Output voltage</b>	<b>Output intensity</b>
P10F	100-240 VAC	50-60 Hz	1.5 A/1.6 A/1.7 A/ 2.3 A/2.5 A	19.5 VDC	3.34 A/4.62 A/ 6.7 A

For details, read the safety information that shipped with your computer.

For additional safety best practices information, see the Regulatory Compliance Homepage at [www.dell.com/regulatory\\_compliance](http://www.dell.com/regulatory_compliance).

# Index

## A

airflow, allowing **5**

## B

backup and recovery **45**

battery status light **29**

## C

calling Dell **74**

CDs, playing and creating **45**

computer capabilities **44**

computer, setting up **5**

connect(ing)

to the Internet **18**

Contacting Dell online **76**

customer service **70**

## D

DataSafe Local Backup **64**

DellConnect **70**

Dell Diagnostics **58**

Dell Digital Delivery

install software **22**

Dell Factory Image Restore **67**

Dell Support Center **53**

Diagnostic Checklist **75**

drivers and downloads **79**

DVDs, playing and creating **45**

## E

email addresses

for technical support **71**

## F

finding more information **78**

FTP login, anonymous **71**

## H

hard drive activity light **29**

hardware problems

    diagnosing **57**

Hardware Troubleshooter **57**

help

    getting assistance and support **69**

## I

Internet connection **18**

ISP

    Internet Service Provider **18**

## M

memory problems

    solving **50**

## N

network connection

    fixing **48**

## P

power indicator light **29**

power problems, solving **49**

power strips, using **6**

problems, solving **47**

products

    information and purchasing **72**

## R

resources, finding more **78**

restoring factory image **67**

**S**

- setup, before you begin **5**
- shipping products
  - for return or repair **73**
- SIM card **12**
- software features **44**
- software problems **50**
- solving problems **47**
- specifications **80**
- support email addresses **71**
- support sites
  - worldwide **71**
- System Messages **55**
- System Recovery Media **66**
- system reinstall options **62**
- System Restore **63**

**T**

- Touch Pad
  - Gestures **34**

**V**

- ventilation, ensuring **5**

**W**

- warranty returns **73**
- Windows
  - Program Compatibility Wizard **51**
- Windows, reinstalling **66**
- wired network
  - network cable, connecting **7**
- wireless
  - display **16**
- wireless network connection **48**







Printed in the U.S.A.

[www.dell.com](http://www.dell.com) | [support.dell.com](http://support.dell.com)



09N1F7A04